

REFRIGERATOR MANUFACTURER
Turbo air
 more durable, efficient, beautiful

4184 E. Conant St.
 Long Beach, CA 90808
 Tel. 310-900-1000
 Fax. 310-900-1077
www.turboairinc.com

Project :	
Model # :	
Item # :	Qty :
Available W/H :	
Approval :	

Swing Door Merchandiser

Glass Door Merchandisers
 Refrigerators

Model : TGM-14RV-N6

FEATURES & BENEFITS

- **Hydrocarbon refrigerants (R-600a)**
 With innovative and eco-friendly technology, Turbo Air brings you hydro-carbon refrigerators designed to meet the new standards of the EPA and DOE in 2017. Hydrocarbon refrigerants do not deplete the ozone layer and have very low contribution to global warming (ODP-0, GWP-3).
- **Energy conserving fan control**
 Utilizing algorithmic air circulation for optimal temperature levels, our innovative fan control system conserves energy by at least 15% and increases compressor life by up to 30%.
- **Hot gas condensate system**
 Through Turbo Air's creative innovation, the condensate system surfaces have been specially treated to resist corrosion. This not only increases efficiency without the risk of refrigerant leakage from corrosion, but also prevents the overflow of condensate water.
- **LED advertising panel**
 LED lighting offers 5 times longer lasting life than fluorescents and conserves energy as well.
- **Double pane glass doors with Low-E glass**
 Energy saving double pane glass doors are equipped with Low- emissivity glass, which reduces outer heat gain and decreases energy consumption. It enhances energy efficiency and minimizes condensation. Lightweight door construction also reduces door maintenance and bushing wear, which in turn facilitates smoother door opening.
- **High-density polyurethane insulation**
 The entire cabinet structure and solid doors are foamed-in-place using high density, CFC free polyurethane insulation.
- **Adjustable, heavy duty, PE (polyethylene) coated wire shelves**
- **LED lighting interior**
- **Refrigerator holds 33°F ~ 38°F for the best in beverage preservation**



Model	Swing Door	CU./FT.	#of Shelves	HP	AMPS	Crated Weight (lbs.)	L x D x H (inches)
TGM-14RV-N6	1	12.1	Top : 3 Bottom : 1	1/5	2.2	187	235/8 x 233/8 x 735/8

Model : TGM-14RV-N6

ELECTRICAL DATA	
Voltage	115/60/1
Plug Type	Ⓜ NEMA 5-15P
Full Load Amperes	2.2
Compressor HP	1/5
Cord Length (ft.)	7
Refrigerant	R-600a
DIMENSIONAL DATA	
# of Doors	1
Net Capacity (cu. ft.)	12.1
Ext. Length Overall (in.)	23 ⁵ / ₈ (600mm)
Ext. Depth Overall (in.)*	23 ³ / ₈ (594mm)
Ext. Height Overall (in.)	73 ⁵ / ₈ (1870mm)
Int. Length Overall (in.)	19 (483mm)
Int. Depth Overall (in.)	19 ⁷ / ₈ (504mm)
Int. Height Overall (in.)	57 ¹ / ₂ (1460mm)
Net Weight (lbs.)	168
Gross Weight (lbs.)	187
# of Shelves	Top 3 Bottom 1
Shelf Size (LxD) (in.)	20 ³ / ₈ x 16 ⁷ / ₈
Bottle Capacity	150 (Full) 120 (Load Line)

Design and specifications subject to change without notice.
Actual shipping weight may differ due to extra packing materials for product protection.
* Depth does not include 1-3/8" for door handle.

■ **WARRANTY : 2 Year Parts and Labor Warranty
Additional 3 Year Warranty on Compressor**

- **Anti-corrosion coated evaporator**
- **White color cabinet & black color frame on door**
- **Gravity feed shelf available (optional)**

■ **OPTIONAL ACCESSORIES :**

- Additional PE coated wire shelf: 30278F0300
- Gravity feed shelf: 30278F0400

PLAN VIEW

(unit : inch)

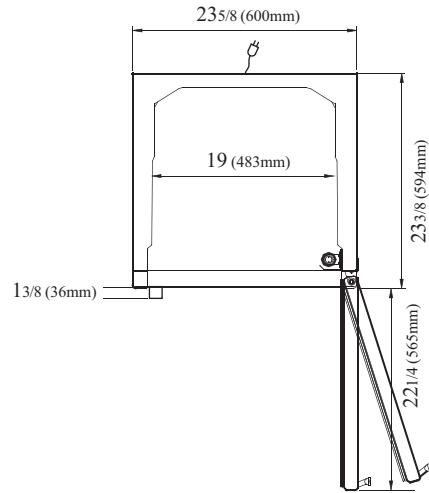

PLAN VIEW

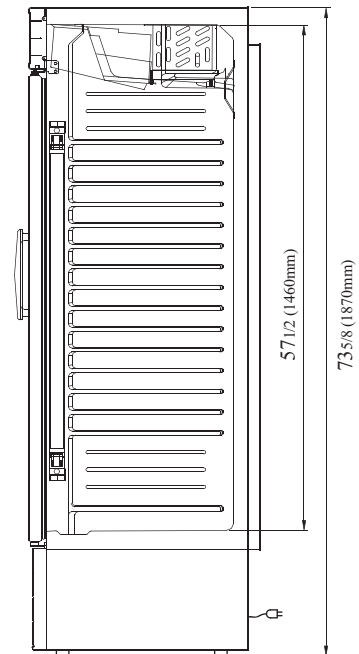

SIDE VIEW

Ver.20171019



- Turbo Air : 800-627-0032
- GK : 800-500-3519
- Warranty : 800-381-7770
- AC : 888-900-1002